

AXIOM®-DV-3 (2U/1L Warmer)

Height: 18.9" Width: 8.4" Depth: 22.1"
(48.0cm) (21.3cm) (56.1cm)



- Adjusts automatically to varying water pressure
- Automatic warmer shut-off
- For high lime areas, BrewLOGIC® technology calculates flow rate and adjusts brew time to maintain consistent pot levels
- Electronic diagnostics and built-in tank drain make service easier
- Ensure coffee quality with programming for brew level, cold brew lock-out and tank temperature, set easily from the front of the machine
- Coffee extraction controlled with programmable pre-infusion, pulse brew and digital temperature control
- Large 200oz. (5.9L) tank provides back-to-back brewing capacity
- Energy-saver mode reduces tank temperature during idle periods
- Hot water faucet
- SplashGard® funnel deflects hot liquids away from the hand
- Dual voltage adaptable (Can operate at 120V/15 amp or 120/208-240V/20 amp)
- PROP 65 Warning Decal included in packaging with equipment
- Servers not included unless otherwise noted

 Server(s) sold separately

Agency:



Specifications

Product #: 38700.0008

Faucet: Upper

Water Access: Plumbed

Warmers: Two Upper/ One Lower

Finish: Stainless

Funnel: Black Plastic

Additional Features

DBC

Electrical & Capacity

Volts*	Amps	Watts	Cord Attached	Plug Type	8oz cups/hr 236ml cups/hr	Input H ₂ O Temp.	Phase	# Wires plus Ground	Hertz
120	15	1800	Yes	NEMA 5-15P	67	60°F (15.5°C)	1	2	60
120/208	16	2980	-	N/A	121	60°F (15.5°C)	1	3	60
120/240	18	3850	-	N/A	121	60°F (15.5°C)	1	3	60

*When a BUNN is machine rated 120/208-240V, 120/208V or 120/240V, the higher voltage is the supply voltage needed to power the machine. The 120V is there to supply power to some components rated 120V in the machine, but it is not the supply voltage and would not power the machine if the machine is marked with the before mentioned ratings.

Plumbing Requirements

PSI	kPa	Fitting Supplied	Water Flow Required (GPM)
20-90	138-621	1/4" Male Flare Fitting	-

CAD Drawings

2D	Revit	KLC
●		

 **WARNING:** This product can expose you to chemicals including Bisphenol A (BPA), which is known to the State of California to cause birth defects or other reproductive harm. For more information go to www.P65Warnings.ca.gov



BUNN® reserves the right to change specifications and product design without notice. Such revisions do not entitle the buyer to corresponding changes, improvements, additions or replacements for previously purchased equipment. For most current specifications and other info visit bunn.com.

Last Updated:
07/13/2022

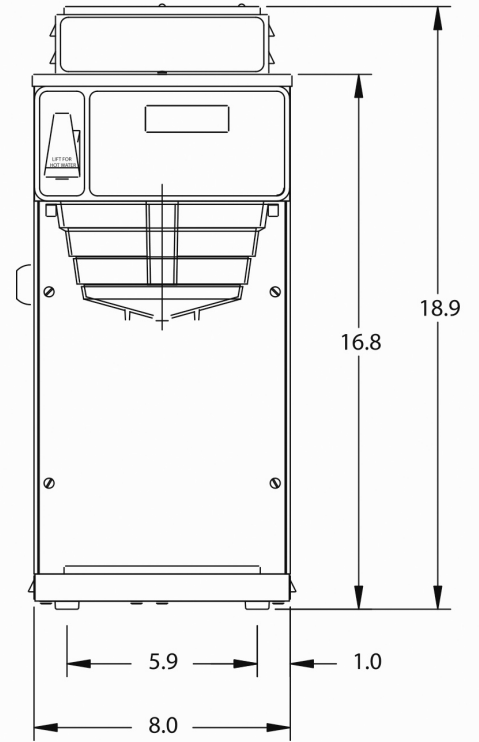
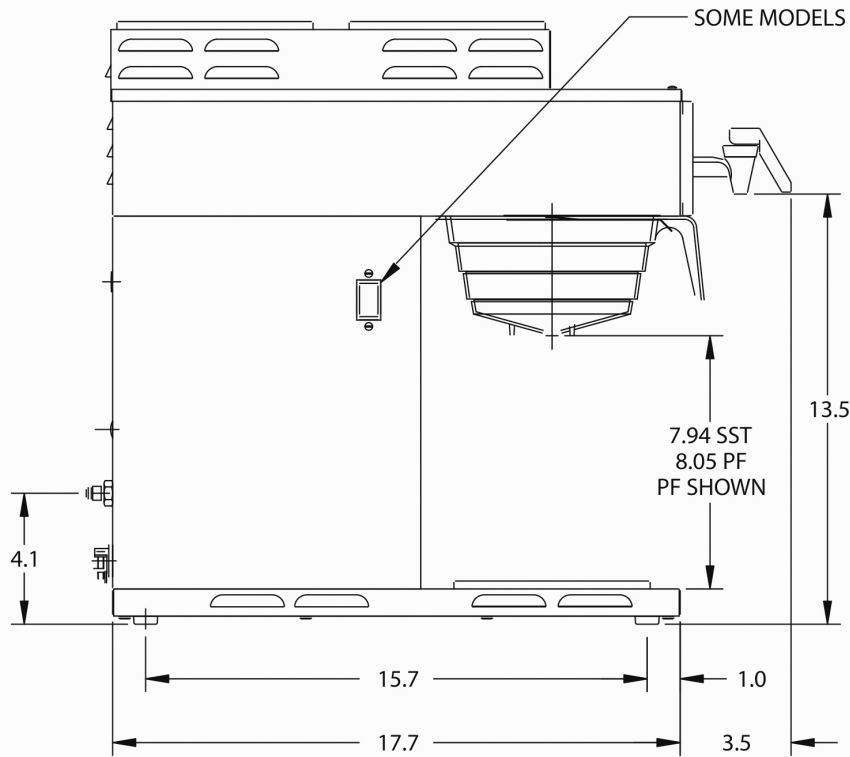
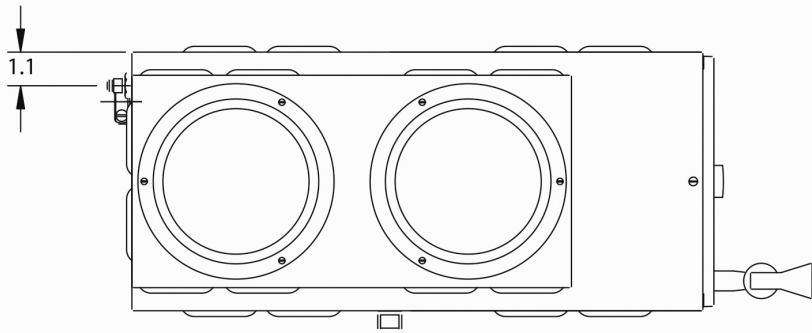

	Unit			Shipping				
	Height	Width	Depth	Height	Width	Depth	Weight	Volume
English	18.9 in.	8.4 in.	22.1 in.	23.8 in.	12.5 in.	26.5 in.	31.300 lbs	4.566 ft ³
Metric	48.0 cm	21.3 cm	56.1 cm	60.3 cm	31.8 cm	67.4 cm	14.198 kgs	0.129 m ³



BUNN® reserves the right to change specifications and product design without notice. Such revisions do not entitle the buyer to corresponding changes, improvements, additions or replacements for previously purchased equipment. For most current specifications and other info visit bunn.com.

Last Updated:
07/13/2022

Related Products & Accessories: AXIOM®-DV-3 (2U/1L Warmer)(38700.0008)



FUNNEL W/DECAL,PPK
NAR BLK(SM)

Product #: 02774.0011



FUNNEL W/DECAL,PPK
NAR BLK(LG)

Product #: 04274.0012



FILTERS,REGULAR1M
500/2 50/CL

Product #: 20115.0000



FUNNEL ASSY, SST-BLK
HDL(7.12)

Product #: 20216.0000



FUNNEL W/DECALS,
BLACK PLASTIC

Product #: 20583.0003



FUNNEL ASSY, SST-PP
BLK HDL

Product #: 29151.0000



FUNNEL ASSY,SST-PP
ORANGE HDL

Product #: 29151.0001



WATER FILTER
SYSTEM,EQ-17-TL

Product #: 30200.1000



WATER FILTER,IN LINE
ED-17-TL

Product #: 30201.1001



SYSTEM, WEQ-10(1.5)5L

Product #: 56000.0024



CARTRIDGE, WEQ-10
(1.5)5L

Product #: 56000.0121



CARTRIDGE, WEQ-10.3
(1.67)5L

Product #: 56000.0137



BUNN® reserves the right to change specifications and product design without notice. Such revisions do not entitle the buyer to corresponding changes, improvements, additions or replacements for previously purchased equipment. For most current specifications and other info visit bunn.com.

Last Updated:
07/13/2022

Serving & Holding Options: AXIOM®-DV-3 (2U/1L Warmer)(38700.0008)



EASY POUR®,(BLK) 1/CS

Product #:06100.0101



EASY POUR®,(BLK) 2/CS

Product #:06100.0102



EASY POUR®,(BLK) 3/CS

Product #:06100.0103



EASY POUR®,(BLK) 6/CS

Product #:06100.0106



EASY POUR®,(BLK) 12/
CS

Product #:06100.0112



EASY POUR®,(BLK) 24/
CS

Product #:06100.0124



EASY POUR®,(ORN) 1/
CS

Product #:06101.0101



EASY POUR®,(ORN) 2/
CS

Product #:06101.0102



EASY POUR®,(ORN) 3/
CS

Product #:06101.0103



EASY POUR®,(ORN) 24/
CS

Product #:06101.0124



DECANTER, GLASS-BLK
12C 24/CS

Product #:42400.0024



DECANTER, GLASS-BLK
12CUP 1PK

Product #:42400.0101



DECANTER, GLASS-BLK
12C 3/CS

Product #:42400.0103



DECANTER, GLASS-ORN
12C 24/CS

Product #:42401.0024



DECANTER, GLASS-
ORN 12 CUP 1PK

Product #:42401.0101



DECANTER, GLASS-ORN
12C 3/CS

Product #:42401.0103



BUNN® reserves the right to change specifications and product design without notice. Such revisions do not entitle the buyer to corresponding changes, improvements, additions or replacements for previously purchased equipment. For most current specifications and other info visit bunn.com.

Last Updated:
07/13/2022